

# **FEDERATION**

---

## **FIREARMS**

**12 GAUGE SPM-12 MAGAZINE FED PUMP ACTION SHOTGUN**



Owner's manual

---

## OWNER'S RECORD

SERIAL# \_\_\_\_\_ DATE \_\_\_\_\_

### CARE AND MAINTENANCE OF YOUR FEDERATION FIREARMS SHOTGUN

#### 1) NEVER ALTER OR MODIFY YOUR SHOTGUN

This shotgun was produced under specific manufacturer guidelines and should not be changed under **ANY** circumstances. Altering the trigger, mechanical components, safety mechanisms, or using any other products other than those provided in the original box is **NOT RECOMMENDED** by the manufacturer, and could result in death, bodily harm, or compromising your safety or the safety of others. Any alteration made to the firearm also voids the factory warranty.

#### 2) PROPER CARE AND MAINTENANCE

It is essential that regular maintenance and cleaning be performed to maintain the accuracy, function, and maximize the longevity of your firearm. Before cleaning **ALWAYS** perform a safety check to make sure that the firearm is unloaded prior to cleaning.

---

## CONGRATULATIONS!

You are now the owner of the Federation Firearms shotgun. Your shotgun has an innovative design and is manufactured from high quality materials. With regularly performed maintenance and the use of proper ammunition it will provide you with many years of service.

In order to achieve the best performance and reliability from your shotgun, please read and fully understand all of the instructions, safety guidelines, and warnings carefully in this manual. Your quality shotgun is extremely reliable and safe unless it is handled in a careless or irresponsible manner. **REMEMBER.... IT IS IMPERATIVE THAT THE FIREARM HANDLER BE FULLY EDUCATED AND CONSCIOUS OF THE IMPORTANCE OF EXECUTING PROPER GUN SAFETY RULES WHEN OPERATING ANY FIREARM.**

Before using or firing with any live ammunition you should know and fully understand your shotgun's parts, function, and operating mechanisms. So carefully read and fully understand all of the information about the parts and procedures of using the shotgun safely and effectively.

## A GUN OWNER'S RESPONSIBILITY

As the owner of a firearm you have the responsibility and obligation of ensuring that any and all shooting activities are safe for everyone. This requires your personal commitment to carefully read, fully understand, and exercise the principles of proper firearm safety at all times.

## DISCLAIMER

THE FIREARM IN WHICH THESE SAFETY RULES APPLY IS SOLD UNDER THE EXPRESSED CONDITIONS THAT THE MANUFACTURER ACCEPTS **NO LIABILITY** IN PART OR WHOLE FOR BODILY INJURY, DEATH, OR PROPERTY DAMAGE FROM:

- IMPROPERLY OR CARELESSLY HANDLING THE FIREARM.
- USING DEFECTIVE, IMPROPER CALIBER, HAND-LOADED, NON STANDARD OR RELOADED AMMUNITION.

- 
- INADEQUATE MAINTENANCE OF THE SHOTGUN RESULTING IN CORROSION OR DAMAGE, NEGLIGENCE OF MALFUNCTIONS.
  - RE SALE IN CONTRADICTION OF ANY APPLICABLE LAWS OR REGULATIONS,
  - ALTERING OR CONVERTING THE FIREARM'S ORIGINAL AESTHETIC, FUNCTIONING MECHANISMS, ACCESSORIES, OR MECHANICAL CONFIGURATION,
  - DISCHARGING WITH CRIMINAL INTENT OR NEGLIGENCE.
  - FAILURE TO UNDERSTAND, ADHERE TO, AND FOLLOW THE RULES OF FIREARM SAFETY WHEN USING OR HANDLING THE FIREARM.
  - OR ANY OTHER CIRCUMSTANCES OUTSIDE THE MANUFACTURER'S DIRECT OR IMMEDIATE CONTROL.

### **FIREARM SAFETY**

**IMPORTANT WARNING:** IT IS IMPORTANT FOR YOU TO RECEIVE PROPER TRAINING FROM A COMPETENT FIREARMS INSTRUCTOR OR AUTHORITY BEFORE BEGINNING TO SHOOT OR WHEN HANDLING THE FIREARM.

**IMPORTANT WARNING:** FAILURE TO ADHERE TO THE RULES OF FIREARM SAFETY CAN RESULT IN SERIOUS INJURY, DEATH, OR DESTRUCTION OF PROPERTY

- 1) COMPLETELY READ AND UNDERSTAND YOUR OWNER'S MANUAL GUIDELINES BEFORE USING YOUR FIREARM.** You should fully understand the function of all of the components and mechanics of the firearm. Before you remove the firearm out of the box thoroughly read the owner's manual on how to properly carry, handle, load, unload, and store your new firearm. Know the rules of proper gun safety and exercise them at all times because failure to do so may result in death or injury to yourself or others. Because it is impossible to list every



---

firearm situation or scenario, be aware that certain circumstances may require additional safety rules unique to a particular situation.

- 2) ALWAYS LEARN THE SPECIFIC MECHANICAL AND HANDLING CHARACTERISTICS OF YOUR SHOTGUN.** All firearms are different thus it is important for you to understand how to properly carry, use, and handle each one according to its specific guidelines. Before using any firearm, one must completely familiarize themselves with the type of firearm and its specific safe handling procedures for loading, unloading, carrying,

**NEVER**

- Give the shotgun to any person who has not thoroughly familiarized himself or herself with all of the information, safety rules, and warnings in the owner's manual.
- 3) ALWAYS KEEP THE FIREARM UNLOADED UNTIL READY TO USE.** Firearms should be kept **unloaded** when not in use. Whenever you pick up a firearm, immediately engage the safety device and remove the magazine to visually inspect the chamber and confirm that it is clear. Always unload all ammunition from the chamber and remove the magazine after: 1) shooting, 2) before putting the firearm away, 3) putting it into a holster, 4) when not in use, and 5) when handing it over to another person.

**NEVER**

- Leave a loaded gun unattended, propped up against a surface, or out of your hands.
- Assume a firearm is unloaded, even if you used it last. Always check to make sure that there is no ammunition and the chamber is clear.
- Load a cartridge into the chamber until you are ready to fire.
- Carry or transport your firearm with live ammunition in the chamber.
- Pass a firearm to another person or accept a firearm from another person, until the cylinder or action is open and you have personally checked that the weapon is completely unloaded.
- Haul a loaded firearm openly or in a carrying case.
- Never transfer or hand a loaded firearm to someone else.

---

**4) ALWAYS KEEP YOUR FINGER OFF THE TRIGGER UNTIL YOU ARE READY TO SHOOT.** When holding the firearm be sure to rest your finger on the trigger guard and along the side of the gun.

**NEVER**

- Touch the trigger until you are ready to fire.
- Engage in horseplay while handling a firearm.
- Rely on the safety devices of the gun. Mechanical safeties are never foolproof and can wear out and malfunction overtime. Remember to always handle all firearms using proper gun safety guidelines.

**5) ALWAYS KEEP THE GUN POINTED IN A SAFE DIRECTION.** A safe direction is one in which an accidental discharge cannot or would not cause injury or harm to yourself or others. Use extreme caution especially when loading and unloading your firearm. When handling any firearm always treat it as if it was loaded and ready to fire, even if you think it is empty. The recommended carrying position of your shotgun is with the hammer in de-cocked position.

**NEVER**

- Point your firearm at anything you don't intend to shoot.
- Use a firearm under the influence of alcohol, drugs, or any other substances that may impair your judgment, skills, or physical abilities.
- Target shoot or hunt with a firearm when you are fatigued or too tired to operate the firearm safely.
- Use your firearm if you have an illness or disability that could compromise your judgment and the safety of yourself or others.

**6) ALWAYS USE THE CORRECT AMMUNITION.** All firearms are manufactured to use a certain caliber or gauge of ammunition. Only use ammunition that the manufacturer has recommended. Always verify before loading that you have the correct ammunition that matches the manufacturer's recommendations. Using improperly reloaded or incorrect ammunition can cause death and injury. This can also damage or destroy your firearm which will void any warranty.

---

## **NEVER**

- Shoot the gun unless you know you have the proper ammunition.
- Use hand loaded, non-standard or reloaded ammunition.
- Fire ammunition that exceeds manufacturer's recommendations and specifications.
- Use old, soiled, or damaged ammunition.
- Use ammunition which does not feed reliably in your particular firearm as it may malfunction at a critical juncture.

**7) ALWAYS STORE YOUR FIREARM IN A SECURED STORAGE AREA TO PREVENT UNAUTHORIZED ACCESS OR USE FROM OTHER INDIVIDUALS.** There are many types of firearm storage devices as well as locking devices that attach directly to the firearm itself. Each individual must consider their particular circumstances so that the firearm is stored and maintained for optimal safety and security. Metal gun safes are recommended over open racks or glass front cabinets. Mechanical safeties built into the firearm can fail and should not be used as a substitute for safe gun handling and adherence to all firearm safety rules. Additionally, always store your ammunition locked up and secured separately from any firearms.

## **NEVER**

- Store or hide a loaded firearm
- Leave your firearms where unauthorized access from other individuals can occur.
- Allow access to individuals who do not understand or follow the rules of proper gun safety
- Leave a unsecured firearm in a bed, drawer, closet, or in a vehicle that could allow access to children or other unauthorized individuals
- Allow children under the age of 18 access to any firearms without close supervision and proper firearm safety training.

---

**8) ALWAYS COMPLY WITH ALL LOCAL, STATE, AND FEDERAL LAWS THAT GOVERN THE OWNERSHIP, STORAGE, CARRYING, AND USE OF FIREARMS.**

**NEVER**

- Vandalize any public or private property by using it as a target.

**9) ALWAYS KNOW YOUR TARGET AND WHAT IS BEYOND.** Before you pull the trigger be sure of your target and what is behind it. Shoot only in areas that have approved backdrops such as a shooting range, or backstops such as a hillside or berm. Also, know how far your shot will travel in case you miss the target or the bullet ricochets.

**NEVER**

- Fire in the direction in which there are people.
- Fire at a sound, movement, or a flash of color.
- Shoot directly upwards or at a high angle of elevation. Firing at or into the air can have enough energy to travel long distances and accidentally injure or kill someone.
- Shoot across a highway or other roadway.

**10) ALWAYS WEAR EYE/ EAR/BODY PROTECTION.** Gases and debris can cause injury so it is very important that one wears protective gear to preserve their hearing and eyesight. Also, while in the field wear at least 1000 square inches or more of blaze orange so that you can be visible by others.

**NEVER**

- Discharge a firearm in a poorly ventilated area.

---

**IMPORTANT WARNING** POSSIBLE LEAD EXPOSURE CAN OCCUR WHEN DISCHARGING FIREARMS IN A POORLY VENTILATED AREA, CLEANING THE FIREARM, OR HANDLING AMMUNITION. LEAD AND ITS COMPONENTS IS A SUBSTANCE KNOWN TO CAUSE BIRTH DEFECTS, REPRODUCTIVE DESTRUCTION/IMPAIRMENT, CANCER, OR OTHER SERIOUS HEALTH CONDITIONS AND INJURY. ALWAYS HAVE ADEQUATE VENTILATION AT ALL TIMES AND WASH YOUR HANDS AND OTHER CONTACT AREAS THOROUGHLY AFTER EACH EXPOSURE.

**11) ALWAYS HANDLE WITH EXTREME CARE IF YOUR GUN FAILS TO FIRE WHEN THE TRIGGER IS PULLED.** If the ammunition doesn't fire when you pull the trigger, STOP! and remember to always keep the firearm pointed in a safe direction. Keep your face away from the breech, then put the safety on, carefully open the action, unload the firearm and dispose of the cartridge safely. Always keep in mind that anytime there is a shell in the chamber, your firearm is **LOADED** and ready to fire. Even if you tried to shoot and the firearm did not fire, always treat it as if it could still discharge.

**12) ALWAYS TREAT THE FIREARM AS IF IT WAS LOADED, EVEN IF THE SAFETY IS POSITIONED CORRECTLY AND KEEP YOUR FINGERS AWAY FROM THE TRIGGER WHEN LOADING AND UNLOADING.** A gun is a mechanical device and is not foolproof and is subject to wear and tear over time. Always keep your fingers away from the trigger when you are loading and unloading. If the manual safety proves to be ineffective for any reason, danger of an unintentional discharge exists, the weapon is then must be immediately unloaded and restricted from further use. Contact the seller so that the gun can be inspected and repaired by an authorized gunsmith.  
**REMEMBER..THAT ANY FIREARM SAFETY MECHANISMS CAN FAIL, EVEN IF THE SAFETY IS ENGAGED. YOU SHOULD ALWAYS ASSUME THAT A FIREARM IS LOADED WHEN HANDLING IT.**

**13) ALWAYS KEEP YOUR SHOTGUN IN THE SAME MECHANICAL AND STRUCTURAL CONFIGURATION AS IT WAS WHEN IT WAS MANUFACTURED.** This shotgun was produced under specific manufacturer guidelines and should not be altered or changed under ANY circumstances. Performing conversions by altering the trigger, mechanical components, safety mechanisms, or using any other products other those provided in the original box is **NOT RECOMMENDED** by the manufacturer, and could result death, bodily harm, or compromising your safety or the safety of others. Any alteration made to the firearm also voids the factory warranty. Like any mechanical device

---

it is subject to normal wear and tear from use. In order to maintain optimal safety and performance it should be periodically serviced. You must regularly clean and lubricate your firearm to maintain its functionality, accuracy, safety, and reliability. Always before cleaning or lubricating any firearm make sure that you perform a safety check to make sure that the firearm is completely unloaded prior to performing any routine maintenance.

## **NEVER**

- Alter, convert, or change your firearm from its original manufacturer's configuration.

**IMPORTANT WARNING** THIS FIREARM WAS DESIGNED TO FUNCTION PROPERLY IN ITS ORIGINAL CONDITION. THE MANUFACTURER WILL NOT BE HELD LIABLE OR LEGALLY RESPONSIBLE FOR ANY ALTERATION PERFORMED ON THE FIREARM AFTER IT LEAVES THEIR CONTROL. ANY CHANGES MADE TO THE FIREARM IS SPECIFICALLY CONTRARY TO OUR INSTRUCTIONS AND WE EXPRESSLY DO NOT AUTHORIZE ANY CHANGES BE MADE AFTER MANUFACTURE. DO NOT JEOPARDIZE THE SAFETY OF YOURSELF OR OTHERS BY MAKING MODIFICATIONS TO YOUR FIREARM.

**14) ALWAYS MAKE SURE THE BARREL IS CLEAR OF ANY OBSTRUCTIONS BEFORE SHOOTING.** Before loading always perform a safety check to make sure that there is no ammunition in the chamber or magazine. Examine the barrel for any obstructions or debris such as excess lubricant, dirt, or grease. If the bore is obstructed it can cause increased pressure causing the barrel to bulge or burst during use. Always use a cleaning rod and patch to remove any residues or obstructions in the barrel. Be familiar with your firearm. If the noise or recoil seems muffled or weak then **STOP!** And proceed to unload your firearm and check to make sure nothing is lodged in the barrel.

---

## **NEVER**

- Try to shoot out an obstruction by loading another shell and firing.

## **SERIAL NUMBER OF THE FIREARM**

The serial number is located on various parts of the shotgun. Each serial number is specific to that shotgun and is used for identification and registration. It is recommended that you record your serial number in your manual and keep the information in a secured location.

## **LOADING THE SHOTGUN**

- 1)** First, point the shotgun in a safe direction. Remember, a safe direction means that the gun is pointed so that even if it were to go off, it would not cause injury, damage, or death. Always perform a safety check to make sure that the chamber is empty.
- 2)** When the magazine is empty, the bolt catch lever holds the bolt open at the rear. Press the magazine release to remove the empty magazine and insert a loaded magazine. Remember to only use ammunition that is recommended by the manufacturer.
- 3)** Push down the bolt catch lever with the thumb of the shooting hand and this will allow the bolt to move forward and chamber a round.

## **THE SHOTGUN IS NOW LOADED AND READY TO FIRE!**

**IMPORTANT WARNING:** ALWAYS UNLOAD YOUR FIREARM IMMEDIATELY AFTER SHOOTING

---

## UNLOADING THE SHOTGUN

1. Point the shotgun in a safe direction. Remember, a safe direction means that the gun is pointed so that even if it were to go off, it would not cause injury, damage, or death.
2. Keep your fingers off the trigger and remove the magazine.
3. Pull back the front grip one or more times to insure the chamber is empty. Watch for a live round or empty case to be ejected. Pull the front grip fully rearward and lock the bolt with the bolt catch lever.
4. Make sure the last round in the chamber has been extracted and ejected. Visually and physically check the chamber and the magazine well to make sure the shotgun has been fully unloaded. Perform a safety check by physically inserting your index finger in the chamber to feel for the presence of a round or cartridge case in the chamber.

### IMPORTANT WARNING

Please note : Removal of your barrel from the receiver is not regular part of the cleaning procedure and shouldy be done for repair or for special circumstances.

To achieve a torque value of 35 ft lbs you must securely hold your receiver in something such as a bench or table vise while firmly tightening the barrel nut.

You can not achive 35 ft lbs by holding the receiver in one hand while tightening the barrel nut with the other.



# EXPLODED VIEW

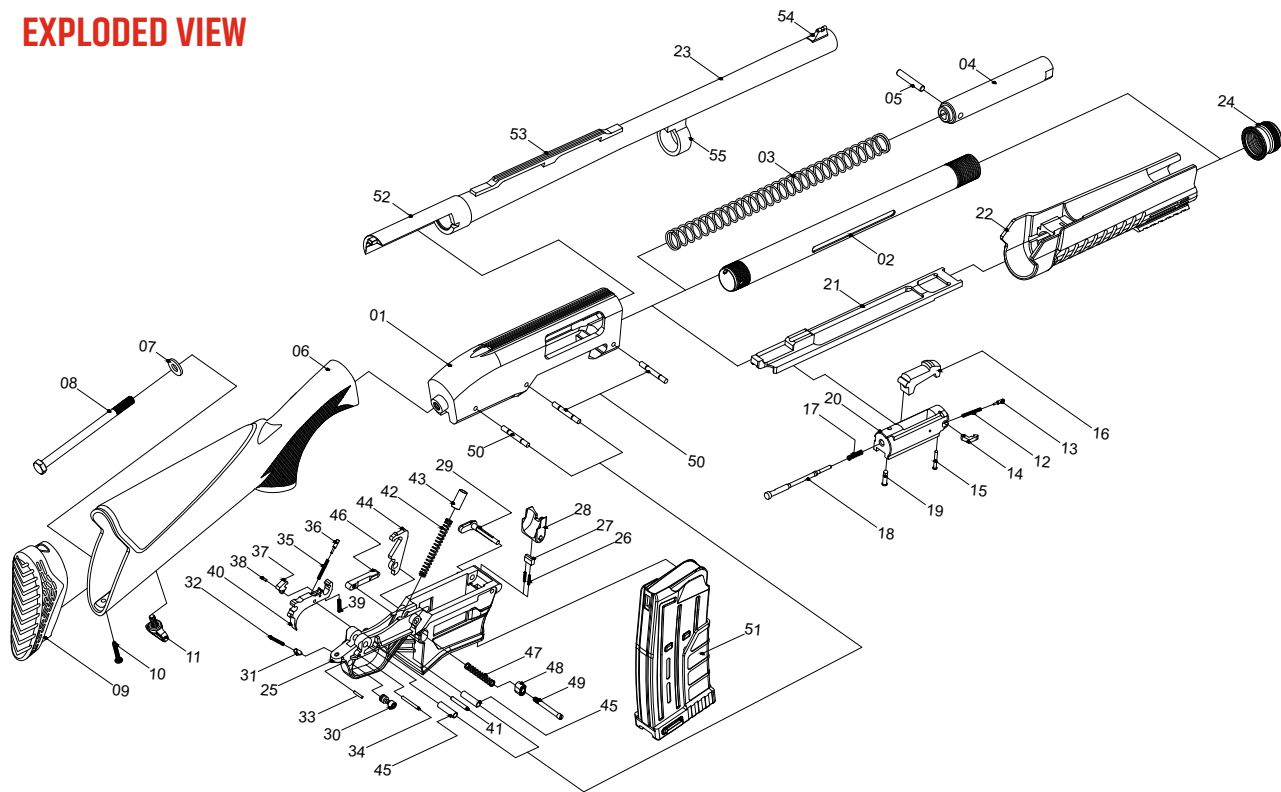

## PART LIST

1	Upper Receiver	29	Cartridge Carrier Catch
2	Recoil Tube	30	Safety
3	Recoil Spring	31	Safety Spring Plug
4	Recoil Spring Plug (Plastic)	32	Safety Spring
5	Handguard Pin	33	Safety Spring Pin
6	Buttstock	34	Trigger Pivot Pin
7	Stock Washer	35	Disconnecter Spring
8	Stock Locking Bolt	36	Disconnecter Spring Pin
9	Buttpad	37	Disconnecter
10	Recoil Pad Screw	38	Disconnecter Assembly Pin
11	Sling Swivel	39	Trigger Spring
12	Extractor Spring	40	Trigger
13	Extractor Spring Pin	41	Trigger Assembly Pin
14	Extractor	42	Hammer Spring
15	Extractor Retaining Pin	43	Hammer Spring Plug
16	Locking Block	44	Hammer
17	Firing Pin Spring	45	Hammer Bushing (2 pieces)
18	Firing Pin	46	Magazine Catch
19	Firing Pin Stop	47	Magazine Plug Spring
20	Bolt	48	Magazine Release Button
21	Bolt Handle	49	Magazine Plug Screw
22	Handguard	50	Receiver Pivot Pin (3 pieces)
23	Barrel	51	Magazine
24	Barrel Assembly Nut	52	Barrel Extension
25	Lower Receiver	53	Line of Sight
26	Cartridge Carrier Spring (2 pieces)	54	Bead Front Sight
27	Cartridge Carrier Spring Plug	55	Barrel Ring
28	Cartridge Carrier		

## SHOTGUN DISASSEMBLY INSTRUCTIONS

**MANUFACTURERS WARNING:** THIS MANUFACTURED FIREARM WAS DESIGNED TO PERFORM WITH ITS ORIGINAL PARTS. IT IS YOUR RESPONSIBILITY TO MAKE SURE THAT ANY PARTS YOU BUY ARE AUTHENTIC AND CORRECTLY INSTALLED AND THAT THE PARTS HAVE NOT BEEN ALTERED OR CHANGED. IT IS IMPERATIVE THAT ONLY FACTORY PARTS BE USED AS REPLACEMENTS TO ASSURE THAT THE FIREARM REMAINS FUNCTIONALLY SAFE AND OPERATES ACCURATELY. THE GUN OWNER ACCEPTS FULL RESPONSIBILITY FOR THE CORRECT REASSEMBLY AND FUNCTIONING OF THE FIREARM AFTER ANY DISASSEMBLY OR REPLACEMENT OF PARTS.

### IMPORTANT WARNING!

**WARNING :** Before you disassemble or clean your firearm, it is your responsibility to check that it is unloaded in a safe manner.

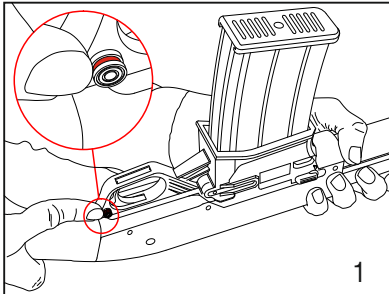

1) Press the safety button first, for safety.

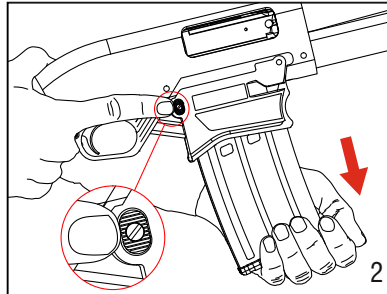

2) Remove the magazine.

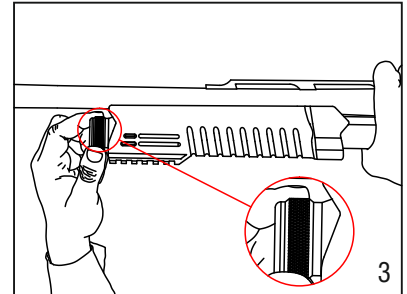

3) Barrel Assembly Nut.

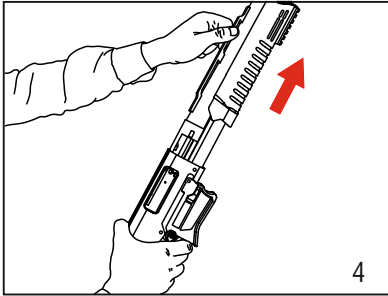

4) Take barrel out.

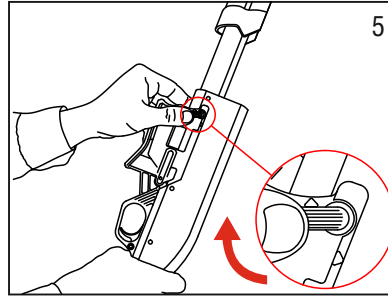

5) Turn ramp lever down.

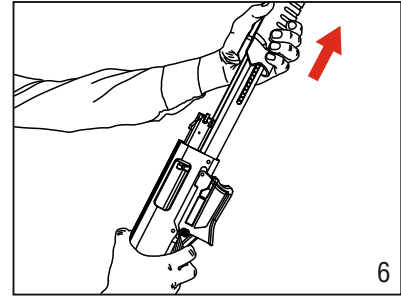

6) Slide handguard and bolt assembly out.

**STEP 1)** DISASSEMBLE YOUR SHOTGUN.

**STEP 2)** USING A PROPER CLEANING ROD, RUN A SOLVENT-WETTED PATCH THROUGH THE BORE SEVERAL TIMES. THIS WILL THEN BE FOLLOWED BY RUNNING DRY PATCHES THROUGH THE BORE TO REMOVE ANY DEBRIS OR RESIDUE.

**STEP 3)** IF THE BORE IS LEADED TO THE EXTENT THAT THE ABOVE PATCH CLEANING PROCEDURE DID NOT REMOVE THE LEAD, THEN SCRUB THE BORE FULL LENGTH WITH A SOLVENT-WETTED BRASS BRISTLE BRUSH. WHEN THE LEADING IS LOOSE THEN REPEAT STEP #2.

**STEP 4)** THE SURFACES OF BOLT CARRIER, EJECTOR, AND INSIDE SURFACES OF THE RECEIVER SHOULD BE COATED VERY LIGHTLY WITH NON-PENETRATING LUBRICATING OIL.

**STEP 5)** REASSEMBLE THE SHOTGUN AND WIPE THE EXTERIOR METAL SURFACES SPARINGLY WITH AN OILED CLOTH. SWAB THE BORE WITH AN OILY PATCH BEFORE STORING THE FIREARM.

**STEP 6)** PLACE THE SHOTGUN IN A SAFE, LOCKED STORAGE SPACE WHERE UNAUTHORIZED PERSONS CANNOT ACCESS THE FIREARM. NEVER STORE THE SHOTGUN IN A LEATHER CASE AS LEATHER ATTRACTS

---

## **WARRANTY INFORMATION**

The manufacturer provides to the original retail purchaser a LIMITED WARRANTY for a period of one (1) year from the date of purchase against defects in material or workmanship. It will be the discretion of the manufacturer and importer as to whether the parts/labor or replacement will result in a charge to the consumer. The importer or manufacturer has the right to research, inspect, and test the weapon to assess any claim made under the warranty.

## **WARRANTY EXCLUSIONS**

The warranty is VOID if the firearm has been altered, abused, misused, damaged by accident, fired with hand loaded or reloaded ammunition, obstructions in the barrel, or damage due to failure to provide regular and necessary maintenance. Also this warranty is VOID if any unauthorized repair or alteration is performed on the firearm.

---

## NOTES

***FEDERATION***   
***FIREARMS***